

KISMET — VANDUTCH



Судостроитель: [VanDutch](#)

Год постройки: 2015

Модель: Моторная яхта

Цена: **ЦЕНА ЯХТЫ ПО ЗАПРОСУ**

Местонахождение: United States

Длина общая: 55' 0" (16.76m)

Ширина: 14' 7" (4.44m)

Крейс. скорость: 36 Kts. (41 MPH)

Макс. скорость: 40 Kts. (46 MPH)

Купить **KISMET — VanDutch** а также выбрать подходящую вам яхту из нашего [каталога яхт](#) вам поможет опытный яхтенный брокер Андрей Шестаков. На сегодняшний день компания **Shestakov Yacht Sales Inc.** имеет большое количество яхт в **собственном списке продаж**, а также тесно сотрудничает со всеми крупными яхтенными производителями по всему миру.

Для того чтобы купить яхту **KISMET — VanDutch** а также проконсультироваться по любому вопросу связанному с покупкой, продажей, чартером яхт позвоните по телефону **+7(918)465-66-44**.

ОГЛАВЛЕНИЕ

ОГЛАВЛЕНИЕ	2
ХАРАКТЕРИСТИКИ	6
Обзор	6
Основная информация	6
Размеры	6
Скорость, вместимость и масса	6
Размещение	7
Корпус и палуба	7
Информация о двигателе	7
ФОТОГРАФИИ	8
DSC_3884	8
2BF91B220AB4619E96A395752821CE20-2	8
DSC_3901	8
DSC_3915	8
DSC_3928	8
DSC_3934	8
DSC_3788	9
DSC_3746	9
DSC_3712	9
DSC_3717	9
DSC_3723	9
DSC_3724	9
DSC_3730	10
DSC_3733	10
DSC_3739	10
DSC_3742	10
DSC_3757-2	10
DSC_3750	10

DSC_3790	11
DSC_3756	11
DSC_3754	11
DSC_3755	11
DSC_3762	11
DSC_3767	11
DSC_3770	12
DSC_3771	12
DSC_3774	12
DSC_3783	12
DSC_3775	12
DSC_3787	12
ED257F34B17BC03B2091CB498FDC3D7B	13
2BF91B220AB4619E96A395752821CE20-2	13
DSC_3712	13
DSC_3717	13
DSC_3723	13
DSC_3724	13
DSC_3730	14
DSC_3733	14
DSC_3739	14
DSC_3742	14
DSC_3746	14
DSC_3750	14
DSC_3754	15
DSC_3755	15
DSC_3757-2	15
DSC_3756	15
DSC_3762	15

DSC_3767	15
DSC_3770	16
DSC_3771	16
DSC_3775	16
DSC_3774	16
DSC_3783	16
DSC_3787	16
DSC_3788	17
DSC_3790	17
DSC_3884	17
DSC_3890	17
DSC_3901	18
DSC_3915	18
DSC_3921	18
DSC_3928	18
DSC_3934	18
ED257F34B17BC03B2091CB498FDC3D7B	18
DSC_3712	19
2BF91B220AB4619E96A395752821CE20-2	19
DSC_3717	19
DSC_3723	19
DSC_3724	19
DSC_3730	19
DSC_3733	20
DSC_3739	20
DSC_3742	20
DSC_3746	20
DSC_3750	20
DSC_3754	20

DSC_3755	21
DSC_3756	21
DSC_3757-2	21
DSC_3762	21
DSC_3767	21
DSC_3770	21
DSC_3771	22
DSC_3774	22
DSC_3775	22
DSC_3783	22
DSC_3788	23
DSC_3787	23
DSC_3790	23
DSC_3884	23
DSC_3901	24
DSC_3890	24
DSC_3915	24
DSC_3921	24
DSC_3928	24
DSC_3934	24
КОНТАКТЫ	25
Контактная информация	25
Телефоны	25
Время работы	25
Адрес	25

ХАРАКТЕРИСТИКИ

Обзор

Full new paint job November 2019

New interior AC compressor and serviced A/C system 7-20-2020

Engines volvo IPS 900

695 hours on the engines. serviced 7-21-2020

Generator Onan 1197 hours. Serviced 7-21-2020

Simrad dual screens

Simrad autopilot

Bow and stern trusters

Batteries replaced 1-1-2020

Original owner

Основная информация

Тип судна: Моторная яхта

Модельный год: 2015

Год постройки: 2015

Страна: United States

Размеры

Длина общая: 55' 0" (16.76m)

Ширина: 14' 7" (4.44m)

Скорость, вместимость и масса

Крейс. скорость: 36 Kts. (41 MPH)

Макс. скорость: 40 Kts. (46 MPH)

Объем топливного бака: 660.5 Gallons

Размещение

Всего кают: 2

Корпус и палуба

Материал корпуса: Fiberglass

Информация о двигателе

Двигатели: 2

Производитель: Volvo Penta

ФОТОГРАФИИ

2BF91B220AB4619E96A395752821CE20-2



DSC_3884



DSC_3901

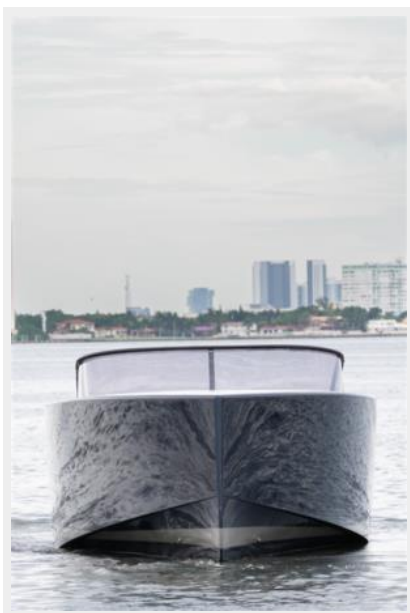

DSC_3915



DSC_3928



DSC_3934



DSC_3746

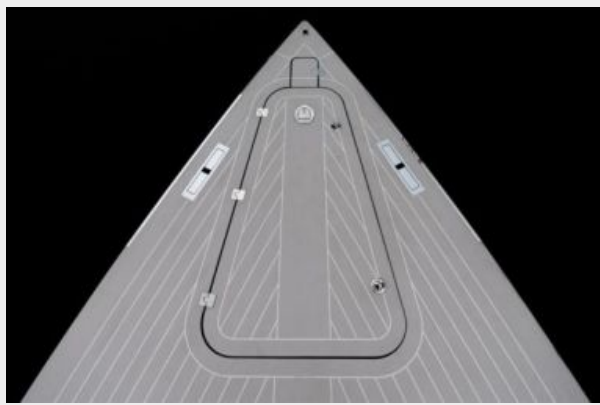

DSC_3788



DSC_3712



DSC_3717



DSC_3723

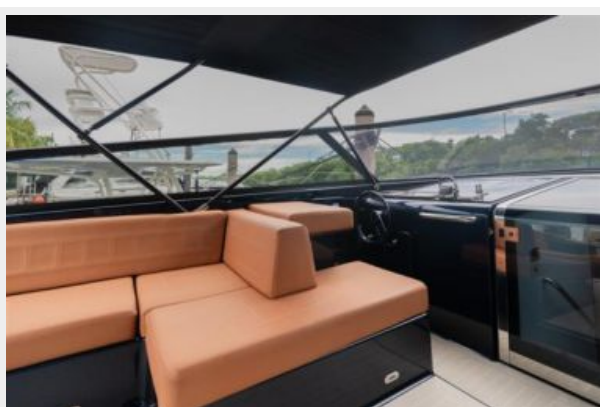

DSC_3724



DSC_3730



DSC_3733



DSC_3739



DSC_3742



DSC_3757-2



DSC_3750



DSC_3790



DSC_3756



DSC_3754



DSC_3755



DSC_3762



DSC_3767



DSC_3770



DSC_3771



DSC_3774

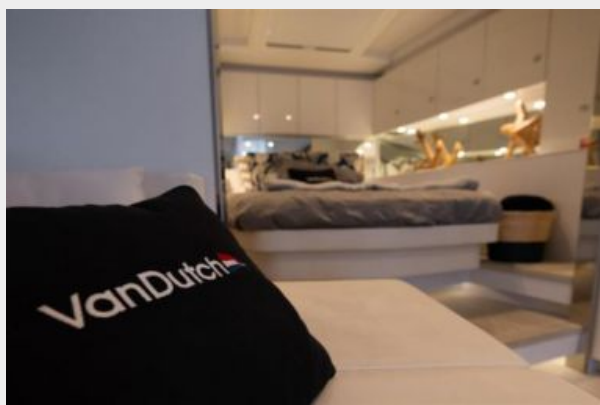

DSC_3783



DSC_3787



DSC_3775

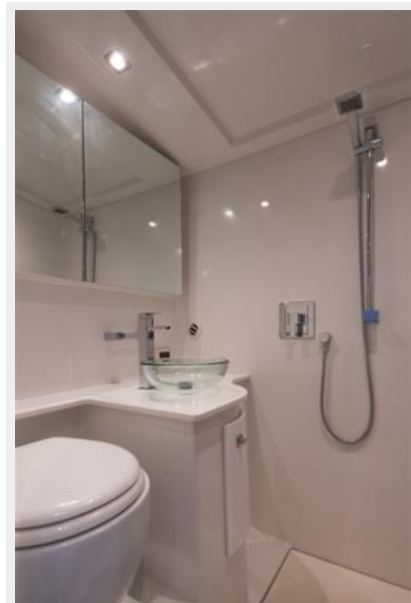

ED257F34B17BC03B2091CB498FDC3D7B 2BF91B220AB4619E96A395752821CE20-2



DSC_3712

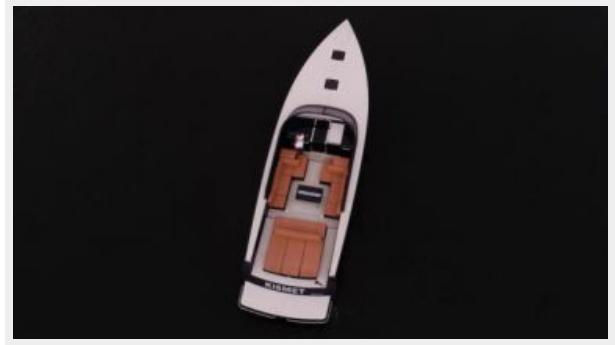

DSC_3717



DSC_3723



DSC_3724

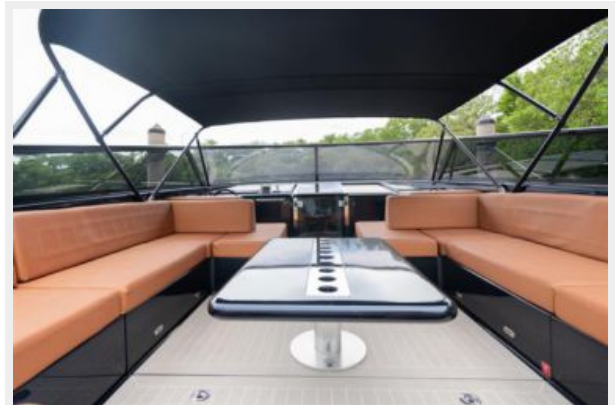

DSC_3730



DSC_3733



DSC_3739



DSC_3742



DSC_3746

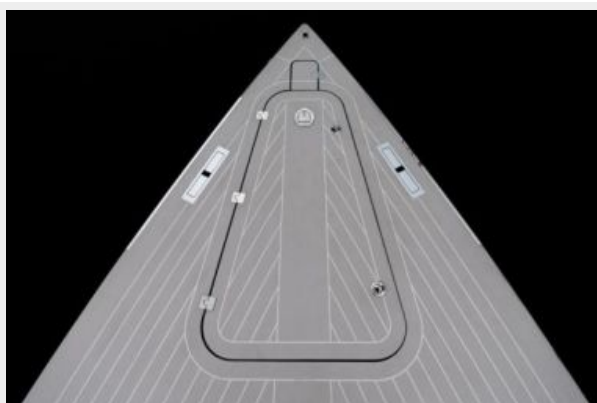

DSC_3750



DSC_3754



DSC_3755



DSC_3756



DSC_3757-2



DSC_3762



DSC_3767



DSC_3770



DSC_3771



DSC_3775



DSC_3774

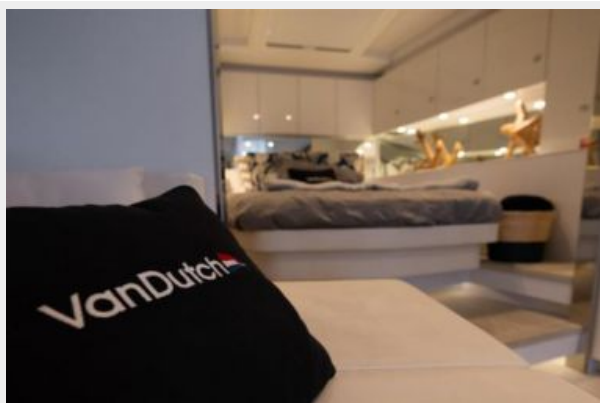

DSC_3783



DSC_3787



DSC_3788



DSC_3790



DSC_3884



DSC_3890



DSC_3901

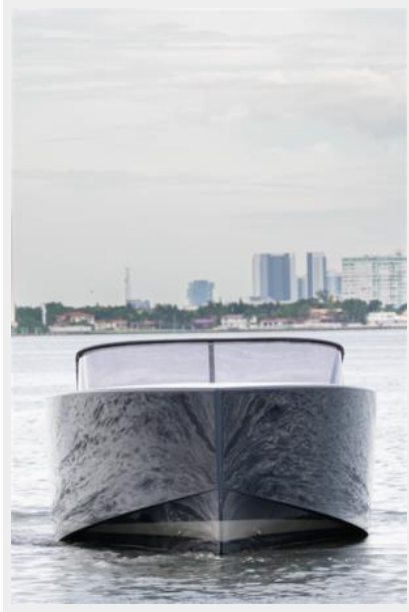

DSC_3915



DSC_3921



DSC_3928



DSC_3934



ED257F34B17BC03B2091CB498FDC3D7B



2BF91B220AB4619E96A395752821CE20-2

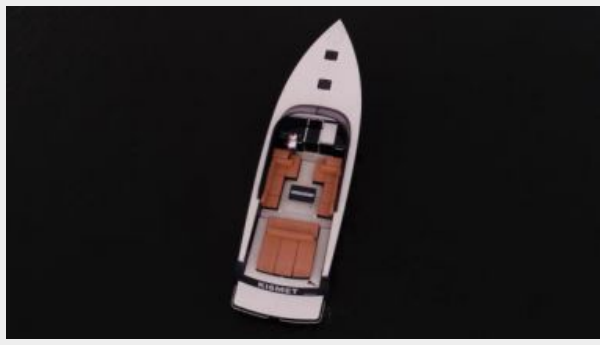

DSC_3712



DSC_3717



DSC_3723



DSC_3724

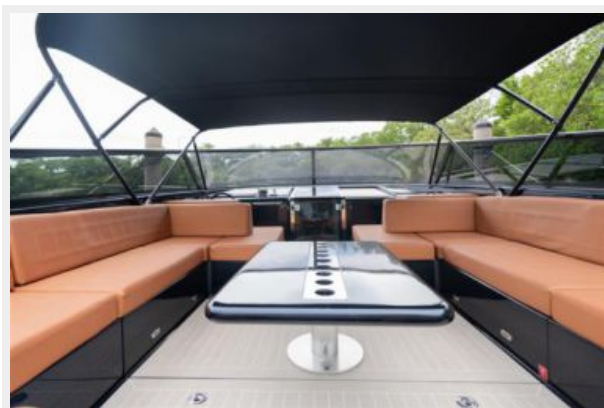

DSC_3730



DSC_3733



DSC_3739



DSC_3742



DSC_3746

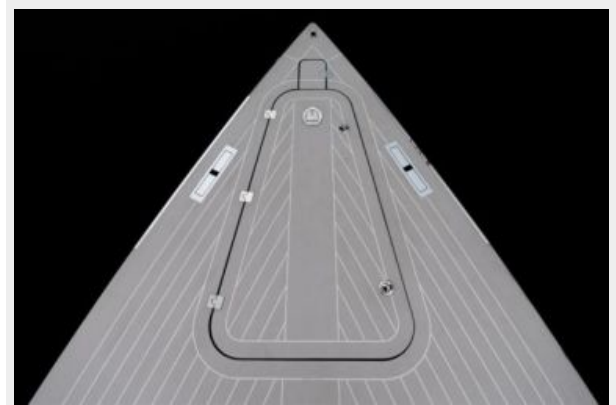

DSC_3750



DSC_3754



DSC_3755



DSC_3756



DSC_3757-2



DSC_3762



DSC_3767



DSC_3770



DSC_3771



DSC_3774

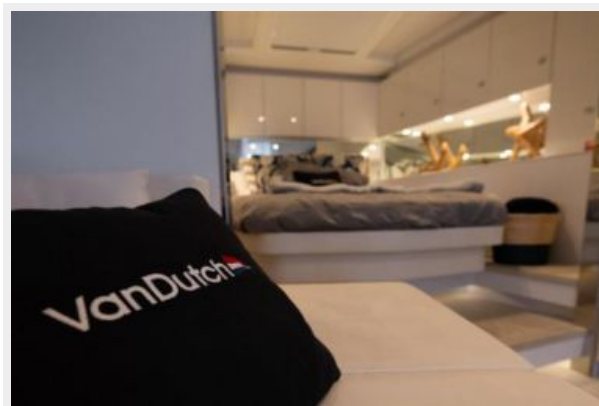

DSC_3775



DSC_3783



DSC_3787



DSC_3788



DSC_3790



DSC_3884



DSC_3890



DSC_3901

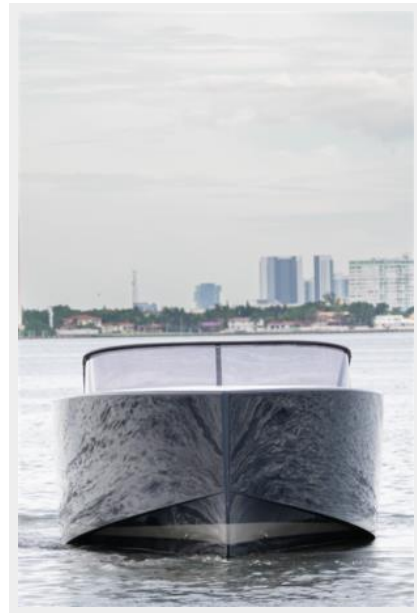

DSC_3915



DSC_3921



DSC_3928



DSC_3934



КОНТАКТЫ

Андрей Шестаков (Andrey Shestakov) – ведущий яхтенный брокер отдела продаж яхт и судов компании Shestakov Yacht Sales Inc. Официальный представитель Shestakov Yacht Sales Inc. для русскоговорящих клиентов в центральном офисе компании в Майами/Форт Лодердейл/Флорида/США.

Контактная информация

Email: andrey@shestakovyachtsales.com

Web: shestakovyachtsales.com

Телефоны

Краснодарский край: **+7(918)465-66-44**

США, Майами, Флорида: **+1(954)274-4435**

Время работы

Понедельник – Суббота: **9:00 - 21:00**
EDT

Воскресенье: **Закрето**

Адрес



Harbour Towne Marina, 850 NE 3rd St,
STE 213, Dania, FL 33004