

## SECOND THOUGHTS — SUNSEEKER



**Builder:** SUNSEEKER

**Year Built:** 2004

**Model:** Motor Yacht

**Price:** \$899,000 USD

**Location:** United States

**LOA:** 68' (20.73mm)

**Beam:** 17.08

**Max Draft:** 4' 8" (1.42mm)

Our experienced yacht broker, Andrey Shestakov, will help you choose and buy a yacht that best suits your needs **Second Thoughts — SUNSEEKER** from our catalogue. Presently, at Shestakov Yacht Sales Inc., we have a wide variety of yachts available on our sale's list. We also work in close contact with all the big yacht manufacturers from all over the world.

If you would like to buy a yacht **Second Thoughts — SUNSEEKER** or would like help answering any questions concerning purchasing, selling or chartering a yacht, please call **+1(954)274-4435**

# TABLE OF CONTENTS

TABLE OF CONTENTS	2
SPECIFICATIONS	5
Overview	5
Basic Information	5
Dimensions	5
Speed, Capacities and Weight	5
Accommodations	5
Hull and Deck Information	5
Engine Information	6
PHOTOS	7
2_2004 68ft Sunseeker Predator SECOND THOUGHTS	7
3_2004 68ft Sunseeker Predator SECOND THOUGHTS	7
4_2004 68ft Sunseeker Predator SECOND THOUGHTS	7
5_2004 68ft Sunseeker Predator SECOND THOUGHTS	7
6_2004 68ft Sunseeker Predator SECOND THOUGHTS	7
7_2004 68ft Sunseeker Predator SECOND THOUGHTS	7
8_2004 68ft Sunseeker Predator SECOND THOUGHTS	8
9_2004 68ft Sunseeker Predator SECOND THOUGHTS	8
10_2004 68ft Sunseeker Predator SECOND THOUGHTS	8
11_2004 68ft Sunseeker Predator SECOND THOUGHTS	8
12_2004 68ft Sunseeker Predator SECOND THOUGHTS	8
13_2004 68ft Sunseeker Predator SECOND THOUGHTS	8
14_2004 68ft Sunseeker Predator SECOND THOUGHTS	9
15_2004 68ft Sunseeker Predator SECOND THOUGHTS	9
16_2004 68ft Sunseeker Predator SECOND THOUGHTS	9
17_2004 68ft Sunseeker Predator SECOND THOUGHTS	9
18_2004 68ft Sunseeker Predator SECOND THOUGHTS	9
19_2004 68ft Sunseeker Predator SECOND THOUGHTS	9

---

20_2004 68ft Sunseeker Predator SECOND THOUGHTS	10
21_2004 68ft Sunseeker Predator SECOND THOUGHTS	10
22_2004 68ft Sunseeker Predator SECOND THOUGHTS	10
23_2004 68ft Sunseeker Predator SECOND THOUGHTS	10
24_2004 68ft Sunseeker Predator SECOND THOUGHTS	10
25_2004 68ft Sunseeker Predator SECOND THOUGHTS	10
26_2004 68ft Sunseeker Predator SECOND THOUGHTS	11
27_2004 68ft Sunseeker Predator SECOND THOUGHTS	11
28_2004 68ft Sunseeker Predator SECOND THOUGHTS	11
29_2004 68ft Sunseeker Predator SECOND THOUGHTS	11
30_2004 68ft Sunseeker Predator SECOND THOUGHTS	11
31_2004 68ft Sunseeker Predator SECOND THOUGHTS	11
32_2004 68ft Sunseeker Predator SECOND THOUGHTS	12
33_2004 68ft Sunseeker Predator SECOND THOUGHTS	12
34_2004 68ft Sunseeker Predator SECOND THOUGHTS	12
35_2004 68ft Sunseeker Predator SECOND THOUGHTS	12
36_2004 68ft Sunseeker Predator SECOND THOUGHTS	12
37_2004 68ft Sunseeker Predator SECOND THOUGHTS	12
38_2004 68ft Sunseeker Predator SECOND THOUGHTS	13
39_2004 68ft Sunseeker Predator SECOND THOUGHTS	13
40_2004 68ft Sunseeker Predator SECOND THOUGHTS	13
41_2004 68ft Sunseeker Predator SECOND THOUGHTS	13
42_2004 68ft Sunseeker Predator SECOND THOUGHTS	13
43_2004 68ft Sunseeker Predator SECOND THOUGHTS	13
44_2004 68ft Sunseeker Predator SECOND THOUGHTS	14
45_2004 68ft Sunseeker Predator SECOND THOUGHTS	14
46_2004 68ft Sunseeker Predator SECOND THOUGHTS	14
47_2004 68ft Sunseeker Predator SECOND THOUGHTS	14
CONTACTS	15

---

---

Contact details	15
Telephones	15
Office hours	15
Address	15

---

# SPECIFICATIONS

---

## Overview

---

This 68 Predator is probably the best maintained and cleanest 68 on the market today. "Second Thoughts" is ready to cruise. She had new MAN 1550 CRM engines installed in 2010, hull painted in 2019, bottom and props redone late 2020. Numerous updates- too many to mention! Call for additional information.

## Basic Information

---

**Category:** Motor Yacht

**Model Year:** 2004

**Year Built:** 2004

**Country:** United States

## Dimensions

---

**LOA:** 68' (20.73mm)

**LWL:** 53' 3" (16.23mm)

**Beam:** 17.08

**Max Draft:** 4' 8" (1.42mm)

## Speed, Capacities and Weight

---

**Water Capacity:** 200 Gallons

**Holding Tank:** 100 Gal Gallons

**Fuel Capacity:** 1030 Gal Gallons

## Accommodations

---

**Total Cabins:** 3

**Total Heads:** 3

## Hull and Deck Information

---

**Hull Material:** Fiberglass

---

## Engine Information

---

**Engines:** 2

**Manufacturer:** MAN

**Engine Type:** Inboard

**Fuel Type:** Diesel

# PHOTOS

**2\_2004 68ft Sunseeker Predator SECOND THOUGHTS**



**3\_2004 68ft Sunseeker Predator SECOND THOUGHTS**



**4\_2004 68ft Sunseeker Predator SECOND THOUGHTS**



**5\_2004 68ft Sunseeker Predator SECOND THOUGHTS**



**6\_2004 68ft Sunseeker Predator SECOND THOUGHTS**



**7\_2004 68ft Sunseeker Predator SECOND THOUGHTS**



**8\_2004 68ft Sunseeker Predator SECOND THOUGHTS**



**9\_2004 68ft Sunseeker Predator SECOND THOUGHTS**

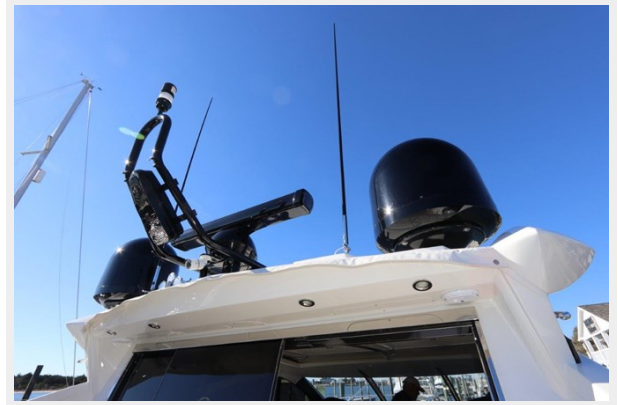

**10\_2004 68ft Sunseeker Predator SECOND THOUGHTS**



**11\_2004 68ft Sunseeker Predator SECOND THOUGHTS**

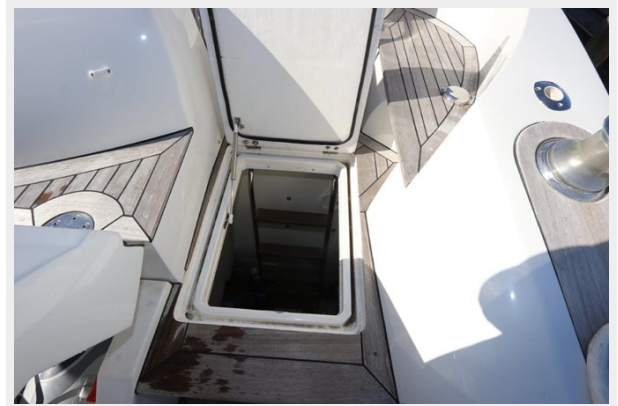

**12\_2004 68ft Sunseeker Predator SECOND THOUGHTS**

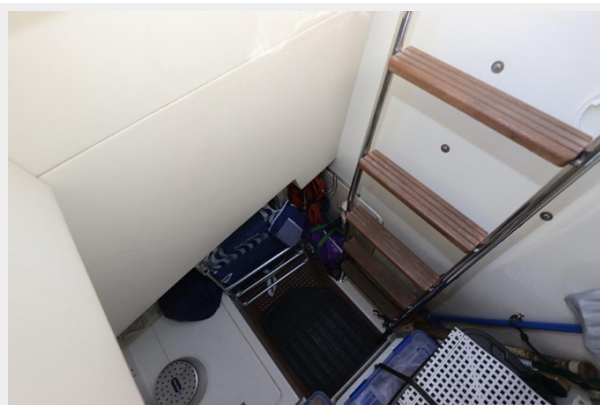

**13\_2004 68ft Sunseeker Predator SECOND THOUGHTS**

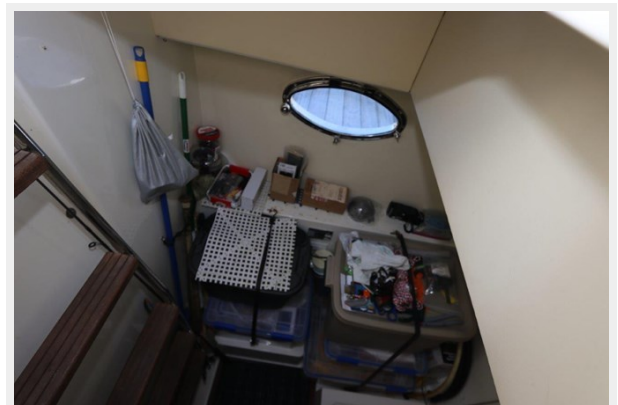



14\_2004 68ft Sunseeker Predator SECOND THOUGHTS



15\_2004 68ft Sunseeker Predator SECOND THOUGHTS



16\_2004 68ft Sunseeker Predator SECOND THOUGHTS



17\_2004 68ft Sunseeker Predator SECOND THOUGHTS



18\_2004 68ft Sunseeker Predator SECOND THOUGHTS



19\_2004 68ft Sunseeker Predator SECOND THOUGHTS



**20\_2004 68ft Sunseeker Predator SECOND THOUGHTS**



**21\_2004 68ft Sunseeker Predator SECOND THOUGHTS**



**22\_2004 68ft Sunseeker Predator SECOND THOUGHTS**



**23\_2004 68ft Sunseeker Predator SECOND THOUGHTS**



**24\_2004 68ft Sunseeker Predator SECOND THOUGHTS**



**25\_2004 68ft Sunseeker Predator SECOND THOUGHTS**



**26\_2004 68ft Sunseeker Predator SECOND THOUGHTS**



**27\_2004 68ft Sunseeker Predator SECOND THOUGHTS**



**28\_2004 68ft Sunseeker Predator SECOND THOUGHTS**



**29\_2004 68ft Sunseeker Predator SECOND THOUGHTS**



**30\_2004 68ft Sunseeker Predator SECOND THOUGHTS**



**31\_2004 68ft Sunseeker Predator SECOND THOUGHTS**



**32\_2004 68ft Sunseeker Predator SECOND THOUGHTS**



**33\_2004 68ft Sunseeker Predator SECOND THOUGHTS**



**34\_2004 68ft Sunseeker Predator SECOND THOUGHTS**



**35\_2004 68ft Sunseeker Predator SECOND THOUGHTS**



**36\_2004 68ft Sunseeker Predator SECOND THOUGHTS**

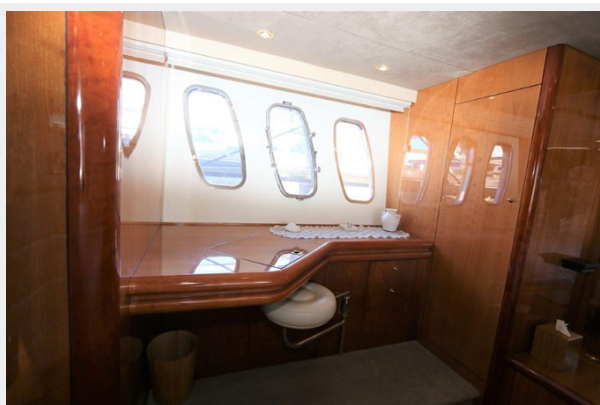

**37\_2004 68ft Sunseeker Predator SECOND THOUGHTS**



**38\_2004 68ft Sunseeker Predator SECOND THOUGHTS**



**39\_2004 68ft Sunseeker Predator SECOND THOUGHTS**



**40\_2004 68ft Sunseeker Predator SECOND THOUGHTS**

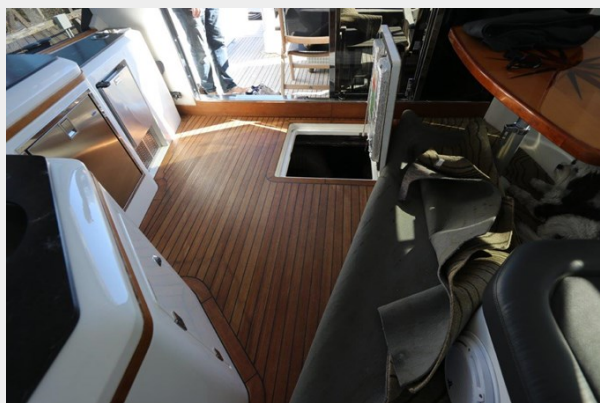

**41\_2004 68ft Sunseeker Predator SECOND THOUGHTS**



**42\_2004 68ft Sunseeker Predator SECOND THOUGHTS**



**43\_2004 68ft Sunseeker Predator SECOND THOUGHTS**



**44\_2004 68ft Sunseeker Predator SECOND THOUGHTS**



**45\_2004 68ft Sunseeker Predator SECOND THOUGHTS**

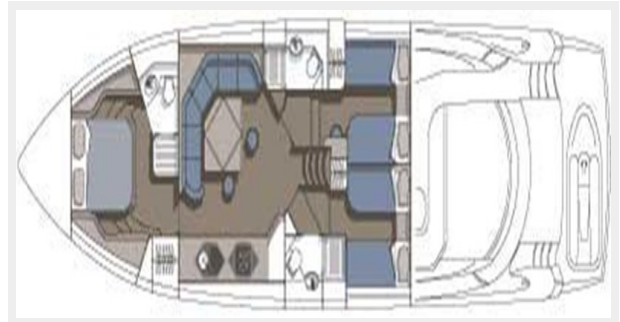

**46\_2004 68ft Sunseeker Predator SECOND THOUGHTS**

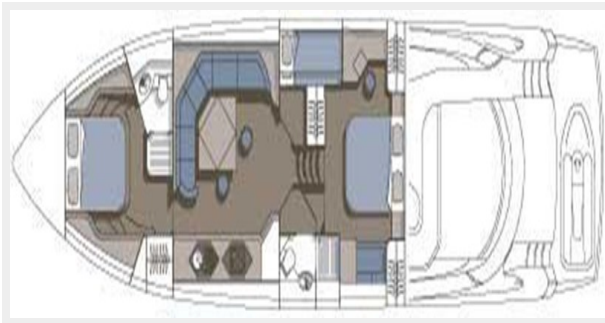

**47\_2004 68ft Sunseeker Predator SECOND THOUGHTS**

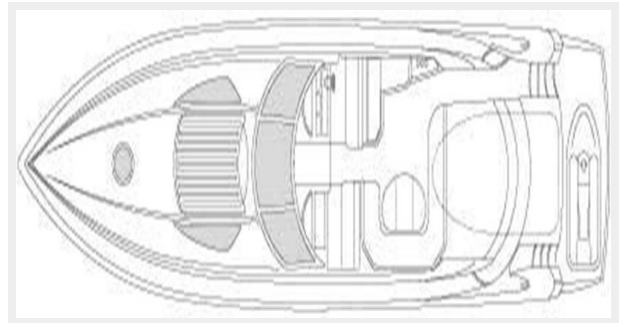

# CONTACTS

---

Andrey Shestakov, leading yacht broker of the sales department of Shestakov Yacht Sales Inc. Shestakov Yacht Sales Inc., the official representative of the Miami/Fort Lauderdale FL headquarters.

## Contact details

---

Email: [andrey@shestakovyachtsales.com](mailto:andrey@shestakovyachtsales.com)

Web: [shestakovyachtsales.com/en/](http://shestakovyachtsales.com/en/)

## Telephones

---

USA: +1(954)274-4435

## Office hours

---

Monday – Saturday: **9:00 - 21:00** EDT

Sunday: **closed**

## Address

---



Harbour Towne Marina, 850 NE 3rd St,  
STE 213, Dania, FL 33004