

## NEW — TESORO YACHTS



**Судостроитель:** TESORO YACHTS

**Год постройки:** 2022

**Модель:** Крейсер

**Цена:** \$795,000 USD

**Местонахождение:** United States

**Длина общая:** 40' (12.19m)

**Ширина:** 12

**Мин. осадка:** 1' 11" (0.58m)

**Крейс. скорость:** 35 Knots Kts. (40 MPH)

**Макс. скорость:** 45 Knots Kts. (52 MPH)

Купить **NEW — TESORO YACHTS** а также выбрать подходящую вам яхту из нашего каталога яхт вам поможет опытный яхтенный брокер Андрей Шестаков. На сегодняшний день компания **Shestakov Yacht Sales Inc.** имеет большое количество яхт в собственном списке продаж, а также тесно сотрудничает со всеми крупными яхтенными производителями по всему миру.

Для того чтобы купить яхту **NEW — TESORO YACHTS** а также проконсультироваться по любому вопросу связанному с покупкой, продажей, чартером яхт позвоните по телефону **+7(918)465-66-44**.

# ОГЛАВЛЕНИЕ

---

ОГЛАВЛЕНИЕ	2
ХАРАКТЕРИСТИКИ	3
Обзор	3
Основная информация	3
Размеры	3
Скорость, вместимость и масса	4
Размещение	4
Корпус и палуба	4
Информация о двигателе	4
ФОТОГРАФИИ	5
КОНТАКТЫ	23
Контактная информация	23
Телефоны	23
Время работы	23
Адрес	23

# ХАРАКТЕРИСТИКИ

## Обзор

• NEW JUST DELIVERED • 2-year Boat Warranty (with option to extend), 10-Year Warranty on the Hull • 30 Demo Engine Hours Only • Twin Mercury 450 Racing Engines (3 Year Warranty – Extendable) (Optional) • 50 MPH Top Speed • Opacmare High-Low Hydraulic Swim Platform (400lbs capacity) • Painted Hull in Whisper Grey Color & Army Grey Waterline Contrast • Silvertex Aluminum Color Upholstery with Diamond Stitching in Dark Grey Contrast • Cullinan Large Hardtop in Carbon Fiber with Glass Sunroof and LED Lights • Underwater Lights in transom and on the sides • Dual Garmin GPSMAP 8616xsv Chartplotter • Garmin Auto Pilot • TV 22" Flushed Mirror in Bow Cabin • Exterior TV 22" With Flushed Mirrored Casing and Lift System • High-Fi Audio System with 8 exterior speakers and Subwoofer. Plus 2 Interior Speakers Controlled via Garmin Screen or Smartphone. With 2 Additional Receivers in Bow and Stern • Additional Cupholders & USB Fast Charging Sockets (interior/Exterior) • 5kw Generator • Bowthruster • Air Conditioning System • Aft Sureshade ATF Large Electric Telescopic Sunshade with Remote Control • Bow Sunshade with Carbon Poles • 2 Large Exterior Isotherm Fridges & 1 Icemaker • Natural Teak Floors with Light Grey Caulking • Cap rails in teak • Pop in – Pop Out Stainless Cleats • Cockpit Table in Stern Painted in Whisper Grey with folding wings • Table (Converts to Solarium) with Silvertex Cushions & Diamond Stitching • Exterior Induction Plate & Sink Area • Interior Cabinet with Special Coffee Machine • Upgraded Batteries • Complete covers for: Helm, Seats, Sunpads, Engines & Table • Fenders with Covers and Storage Racks in Garage area (8) • 2 Exterior Showers Aft. One Inoxstyle Carbon Fiber Shower • Water Heater • Icing Glass with Carbon Trim for windshield and complete Cover for Helm Area

## Основная информация

**Тип судна:** Крейсер

**Подкатегория:** Express

**Модельный год:** 2022

**Год постройки:** 2022

**Страна:** United States

## Размеры

**Длина общая:** 40' (12.19mm)

**Ширина:** 12

**Мин. осадка:** 1' 11" (0.58mm)

## Скорость, вместимость и масса

---

**Крейс. скорость:** 35 Knots Kts. (40 MPH) **Дальность на крейсерской скорости:** 260

**Макс. скорость:** 45 Knots Kts. (52 MPH) **Дальность на макс. скорости:** 200 Kts.

**Вместимость воды:** 69 Gallons **Вместимость сточного бака:** 22 Gal  
Gallons

**Объем топливного бака:** 260 Gal Gallons

## Размещение

---

**Всего кают:** 2

**Всего коек:** 3

**Спальные места:** 4

**Всего ком. состава:** 1

## Корпус и палуба

---

**Материал корпуса:** GRP

**Комплектация корпуса:** Planing

**Цвет корпуса:** Whisper Grey

**Дизайнер корпуса:** Julio Galiana

**Дизайнер экстерьера:** Tesoro Yachts

**Дизайнер интерьера:** Tesoro Yachts

## Информация о двигателе

---

**Двигатели:** 2

**Производитель:** Mercury

**Тип двигателя:** Outboard

**Тип топлива:** Gas/Petrol

# ФОТОГРАФИИ

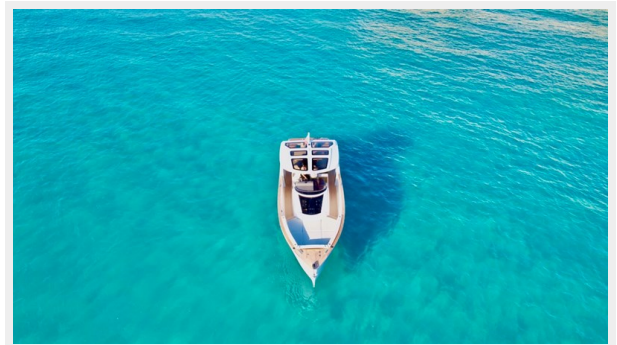
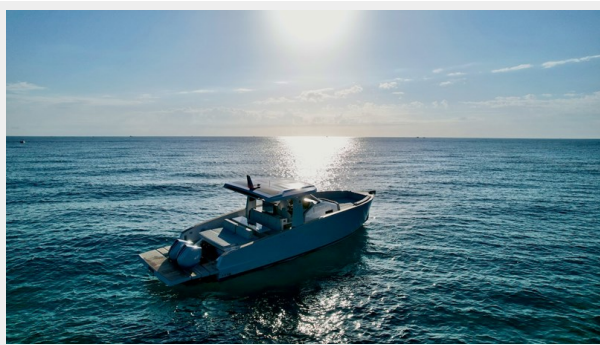

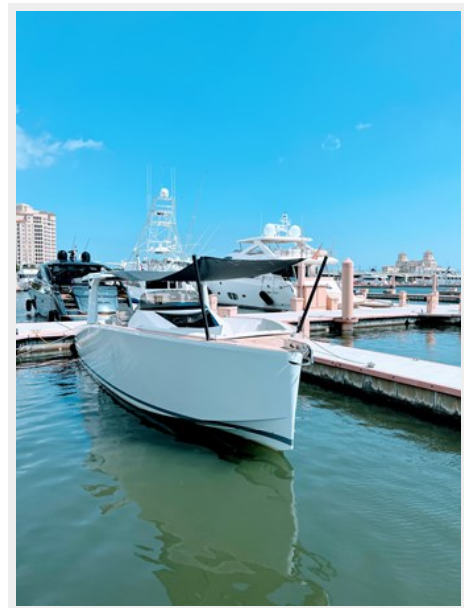

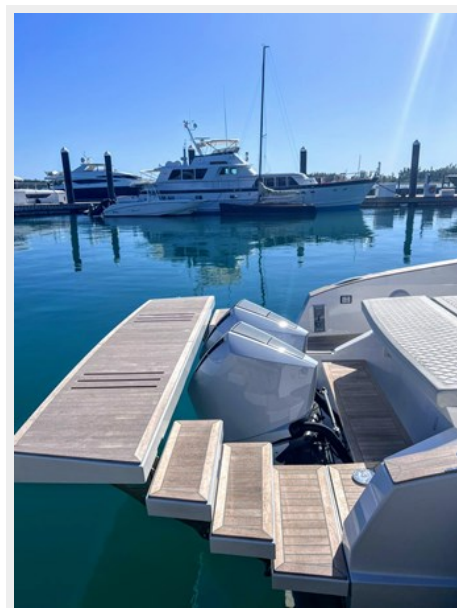

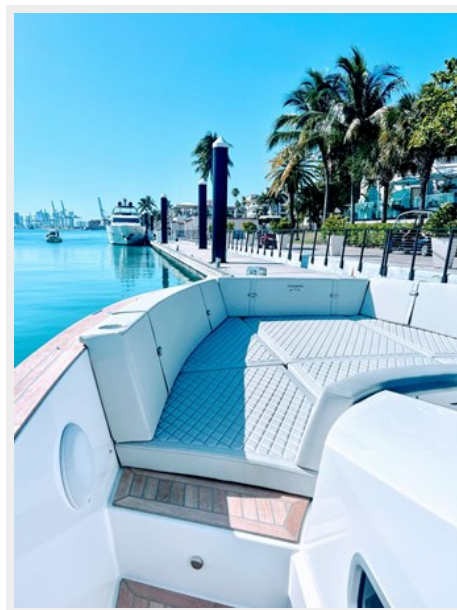







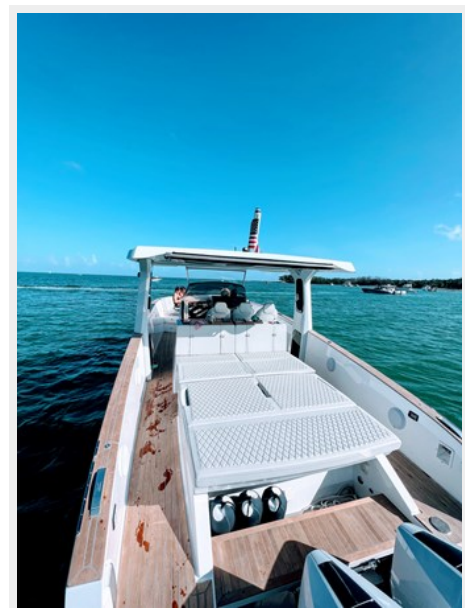
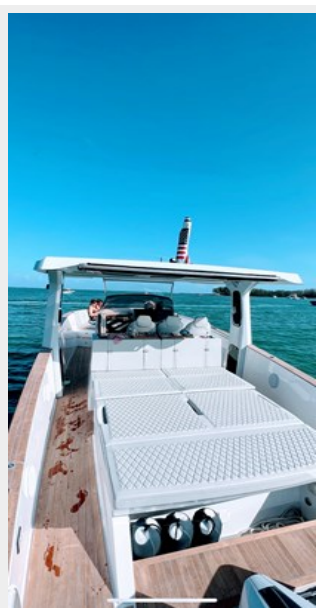



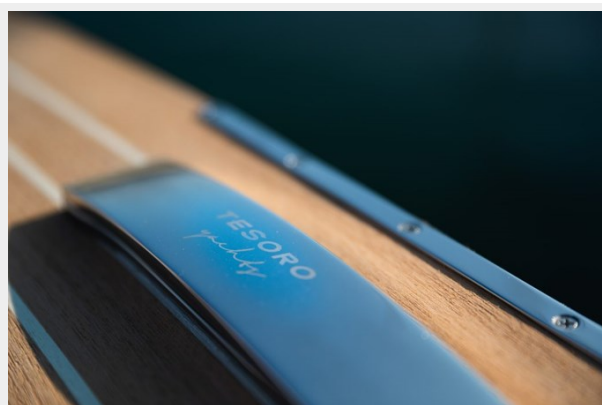
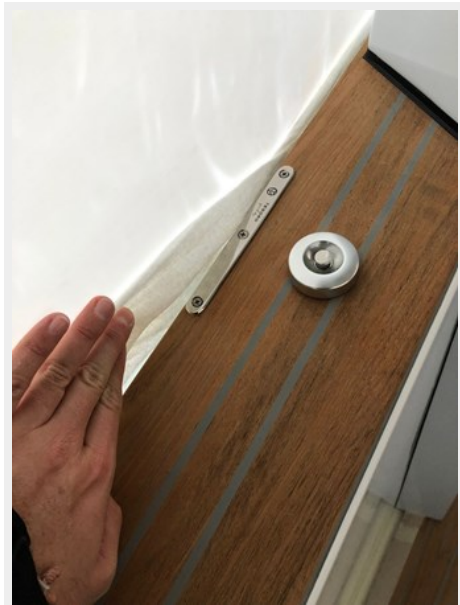
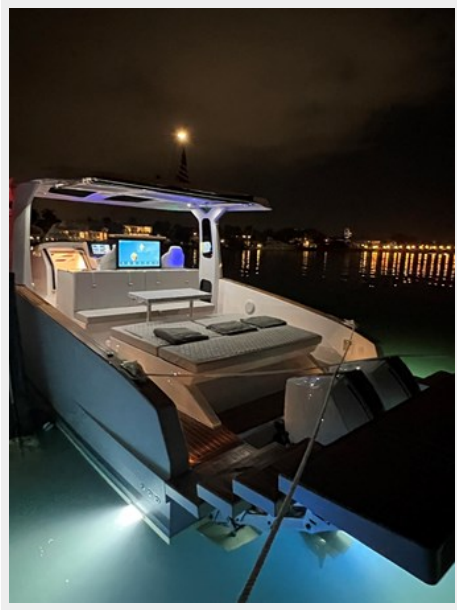

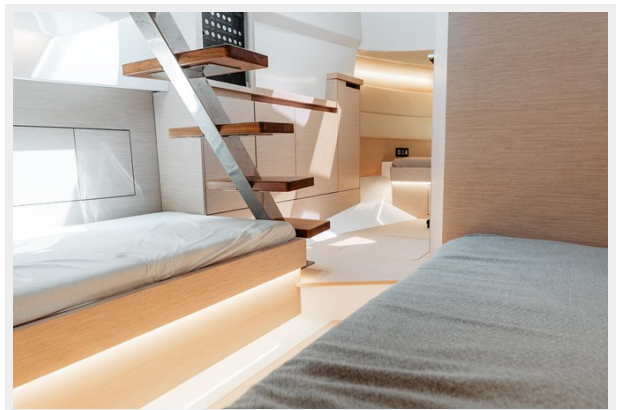
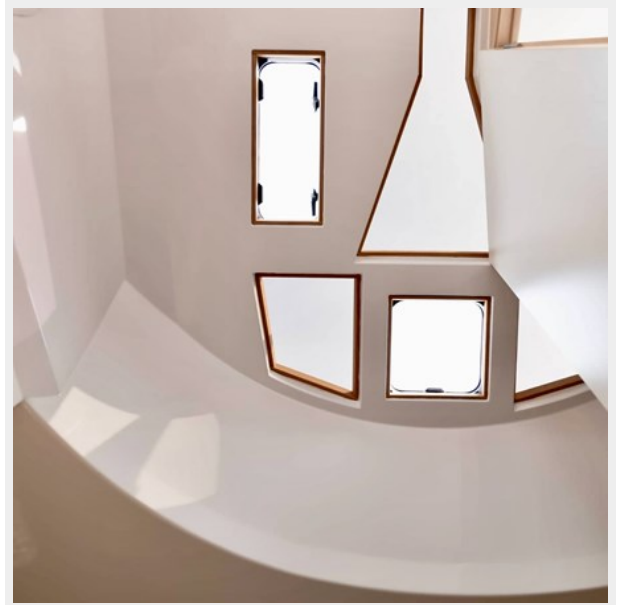

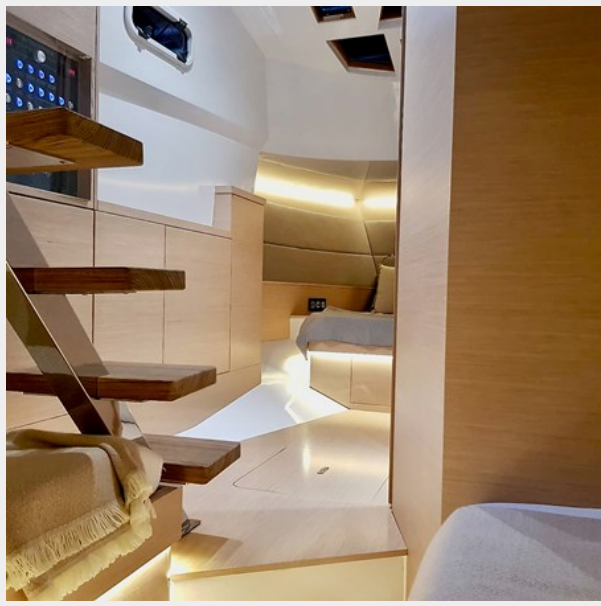

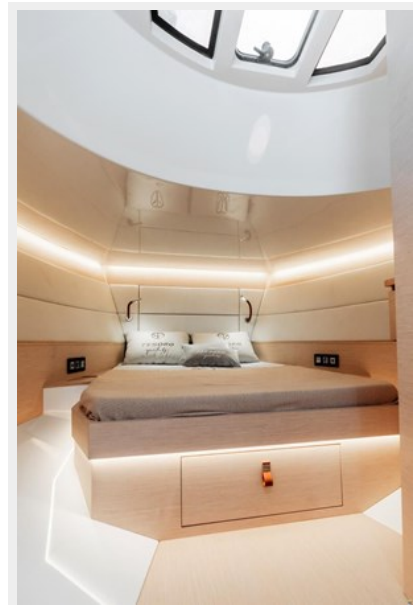



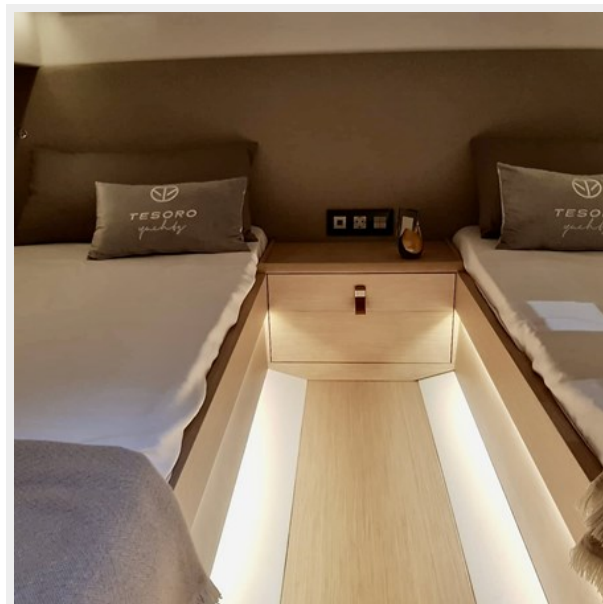
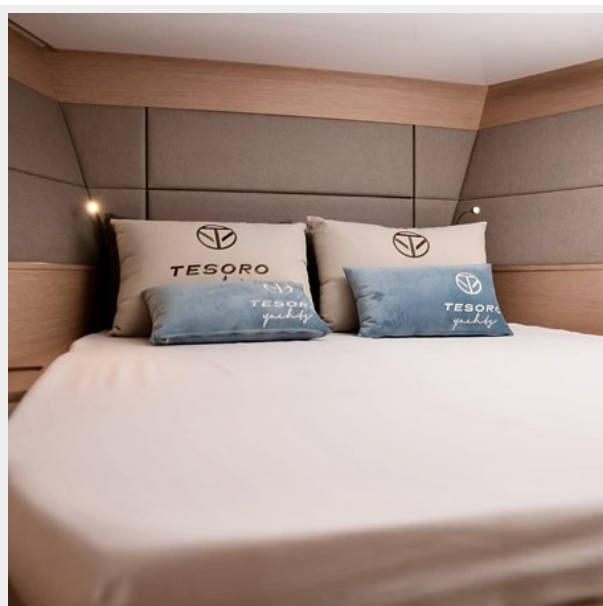

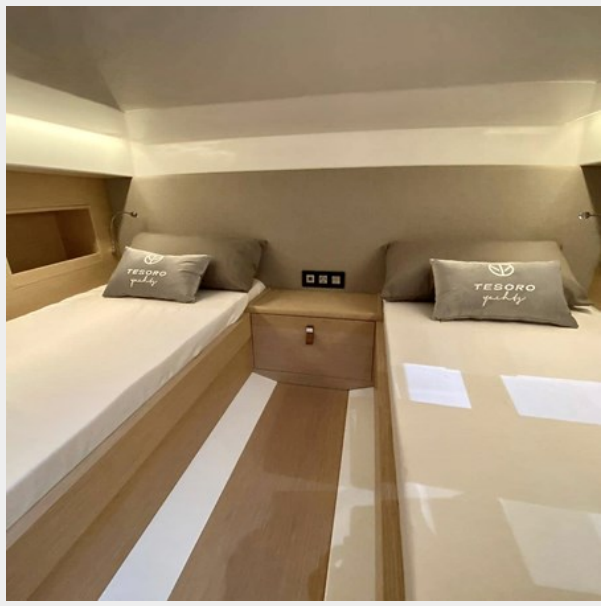

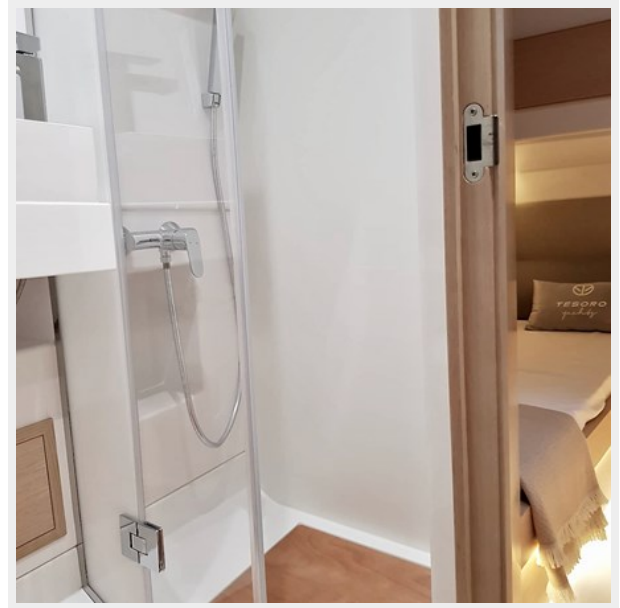

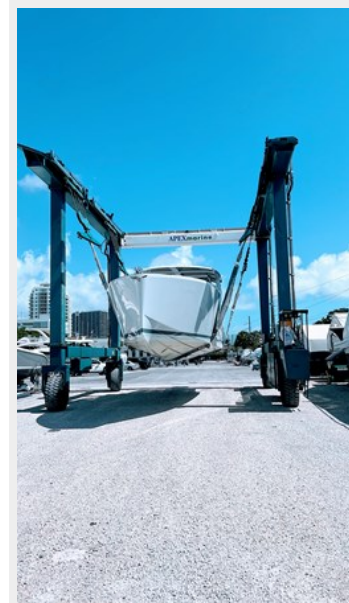

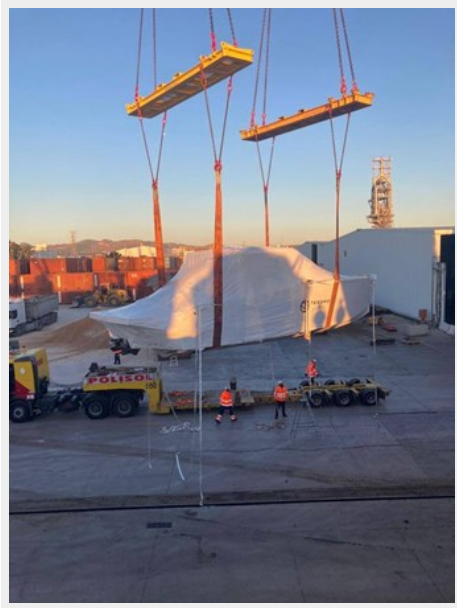

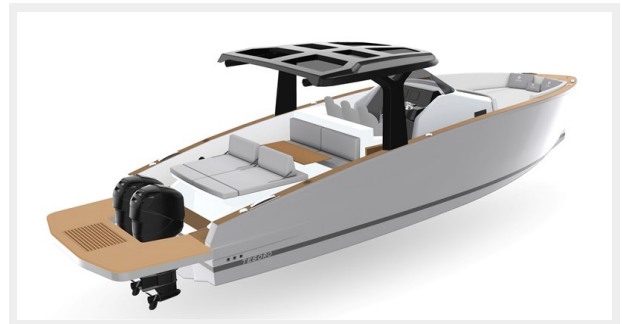

# КОНТАКТЫ

---

Андрей Шестаков (Andrey Shestakov) – ведущий яхтенный брокер отдела продаж яхт и судов компании Shestakov Yacht Sales Inc. Официальный представитель Shestakov Yacht Sales Inc. для русскоговорящих клиентов в центральном офисе компании в Майами/Форт Лодердейл/Флорида/США.

## Контактная информация

---

Email: [andrey@shestakovyachtsales.com](mailto:andrey@shestakovyachtsales.com)

Web: [shestakovyachtsales.com](http://shestakovyachtsales.com)

## Телефоны

---

Краснодарский край: **+7(918)465-66-44**

США, Майами, Флорида: **+1(954)274-4435**

## Время работы

---

Понедельник – Суббота: **9:00 - 21:00**  
EDT

Воскресенье: **Закрето**

## Адрес

---



Harbour Towne Marina, 850 NE 3rd St,  
STE 213, Dania, FL 33004